



USER MANUAL

**HYDRAULIC SQUEEZER
FOR PLASTIC PIPES
MODEL 30 Tm E-99**

Edition: March 2010
Revision No. 0
Publication: MU-71-10E

DATOS DEL FABRICANTE MANUFACTURER DATA	DATOS DEL DISTRIBUIDOR Y SAT DISTRIBUTOR AND SERVICE DATA
<p>ACUSTER GLOBAL, S.L. Juan de la Cierva, 1 Polígono Ind. del Sud-Oest 08960 Sant Just Desvern SPAIN Tel. (+34) 93 470 30 70 Fax (+34) 93 473 00 77 e-mail: info@grupoacuster.com</p>	<p>ACUSTER BAHISA, S.L.U. Juan de la Cierva, 1 Polígono Ind. del Sud-Oest 08960 Sant Just Desvern SPAIN Tel. (+34) 93 470 30 70 Fax (+34) 93 473 00 77 e-mail: info@grupoacuster.com</p>



NOTE !

The modifications carried out against the previous revision of this publication are indicated with || on the right margin.

CONTENTS:

	<u>Page:</u>
CHAPTER 1: INTRODUCTION.....	4
1.1 General.....	4
1.2 Declaration "CE" of conformity.....	5
1.3 Guarantee.....	6
CHAPTER 2: TOOL DESCRIPTION.....	7
2.1 General.....	7
CHAPTER 3: MODE OF USE.....	8
3.1 Instructions for use.....	8
3.1.1 Preliminary steps.....	8
3.1.2 Fitting steps.....	9
CHAPTER 4: MAINTENANCE.....	12
4.1 General.....	12
4.1.1 Introduction.....	12
4.1.2 Storage.....	12
4.1.3 Service.....	12
CHAPTER 5: TECHNICAL CHARACTERISTICS.....	13
5.1 General specifications.....	13

CHAPTER 1: INTRODUCTION

1.1 GENERAL

The 30 Tm hydraulic-style squeezer is a tool used in the maintenance of fluid networks. It is used to squeeze off polyethylene pipes (PE) in order to temporarily interrupt the flow of fluid during manoeuvres carried out by the intervention teams.

It consists of a bottom base composed of a fixed roller provided with two threaded rods and a movable roller, a bridge frame and a hydraulic jack for actuation.

It comes with limit stop plates, selectable according to the pipe diameter and wall thickness (SDR), which limit the squeezing of pipes within the tolerances in accordance with the specifications (in Spain meets the specification EM-M44-E, Part 2, of Gas Natural Fenosa).

During operations with the squeezer should not be removed in any case the limit stop plates.

The squeezer capacity of this model is 30 Tm.

The technical data contained in this *Manual* are purely informative and may be changed at anytime. ACUSTER GLOBAL, S.L. declines all responsibility for claims arising from misuse of the data contained herewith and/or errors or omissions detected after publication.

This *Manual* must be considered as part of the tool.

1.2 DECLARATION "CE" OF CONFORMITY

ACUSTER GLOBAL, S.L.
Juan de la Cierva, 1
Polígono Industrial del Sud-Oest
08960 Sant Just Desvern (Spain)

declare under our sole responsibility that the 30 Tm hydraulic-system squeezer, to which this declaration relates is in conformity with the following Directives and also the following relating standards:

EN ISO 12100-1
EN ISO 12100-2
EN ISO 14121-1
EN ISO 13849-1

meeting the Safety of Machinery Directive:

2006/42/CE

Sant Just Desvern, 9th March 2010

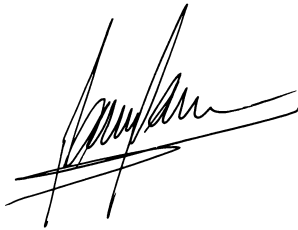

Ramon García Solé
Technical Area Manager

1.3 GUARANTEE

Guarantee Declaration:

All the **30 Tm Hydraulic-style squeezers** are manufactured from high quality material and have been subjected to rigorous tests for resistance and working order as well as passing all the quality control tests required by the applicable normatives (see "CE" Declaration of conformity).

Regardless of whether an incident might occur during the period of guarantee, we recommend careful reading of the following general guarantee conditions.

General conditions of Guarantee:

1. ACUSTER GLOBAL, S.L. guarantees that this product has no manufacturing defect at the time of its purchase and extends this guarantee for the period of ONE year.
2. If the product proves defective during this period, due to the materials or its assembly, it will be repaired free of charge, including the cost of materials and labour at Grupo Acuster's Technical Service.
3. The Guarantee is not valid in the following cases:

When the fault in the product is a result of:

- Abuse or incorrect use of the unit.
 - Not following the instructions specified in this *User Manual* for connecting to a group generator.
 - Repairs carried out without authority from Grupo Acuster (the taking apart or breaking of the unit's seal immediately renders the guarantee invalid).
 - Accidents, natural disasters (including lightning, water action etc) as well as any cause beyond Grupo Acuster's control.
4. In all claims against this guarantee, information relating to the model, date of purchase, Serial number and any other additional information must at all times be stated.

CHAPTER 2: TOOL DESCRIPTION

2.1 GENERAL

The hydraulic-style squeezer is formed by the following components:

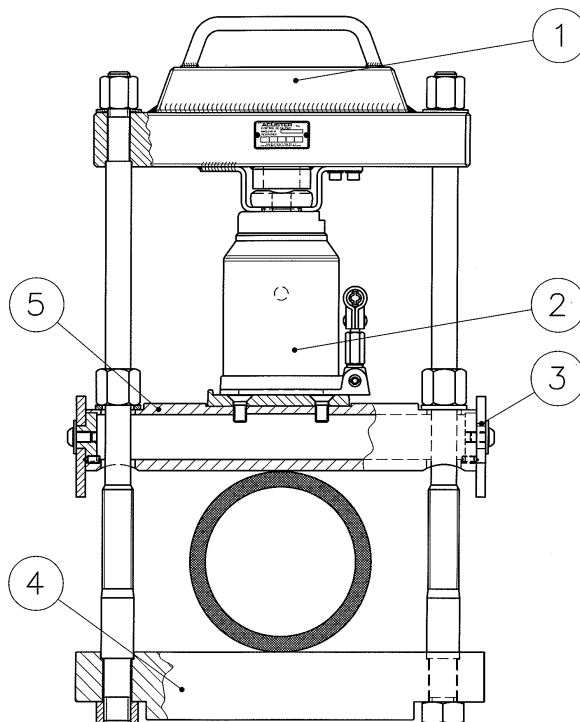

Figure 1: Hydraulic squeezer general view

Where:

- 1 Squeezer frame
- 2 Hydraulic jack
- 3 Limit stop plates
- 4 Bottom bar with guide axles
- 5 Movable bar

CHAPTER 3: MODE OF USE

3.1 INSTRUCTIONS FOR USE

3.1.1 Preliminary steps:

Once prepared the intervention area, place the base of the squeezer on the bottom of the PE pipe to temporarily squeeze off.



WARNING !	
Operators should wear appropriate work clothing, including footwear, eye protection and gloves.	
Select the correct squeezer model according to the diameter and wall thickness of the pipe to be squeezed off. The limit stop plates for the 30 Tm hydraulic squeezer allows the squeezing off of the following PE pipes:	
<i>Standard limit stopper (product code 171089):</i> 90-SDR17.6/90-SDR11 110-SDR17.6/110-SDR11 160-SDR17.6/160-SDR11 200-SDR17.6/200-SDR11	<i>Special limit stopper (product code 171113):</i> 90-SDR11 125-SDR11 180-SDR11

The area where the pipe is going to be squeezed off must be free of any other intervention that has previously been made, as well as remote connections or derivations to the network.

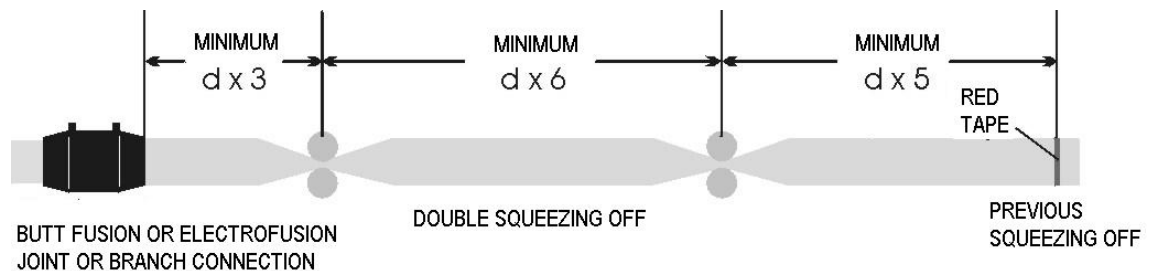

Figure 2: Recommended distance for squeezing off location

Remark: A single squeezer cannot be guaranteed to provide 100% closure, where this is required users are advised to consider using two squeezers.

3.1.2 Fitting steps:

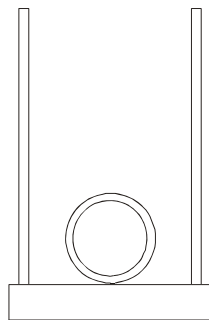

Figure 3

1. Place the lower bar assembly so that the pipe to be squeezed off is positioned in the central part and perpendicular to the lower roller to distribute the squeezing off pressure as possible equidistant.

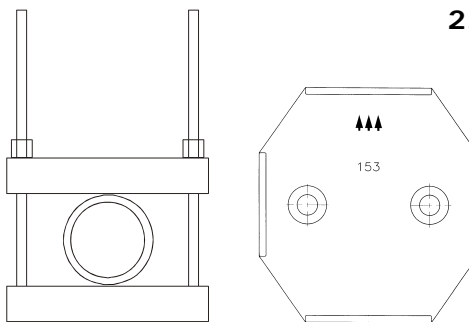

Figure 4

2. Then fit the movable upper roller and their anchoring washers and nuts.

WARNING !
PAY ATTENTION TO THE JACK POSITION. IT HAS A PARTICULAR POSITION ON THE BRACKET.

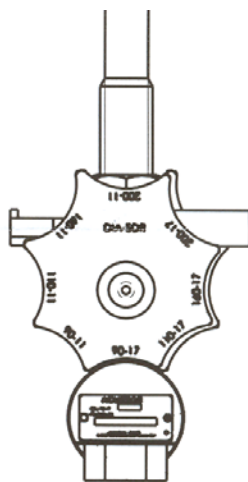

Figure 5

3. Set the limit stop plates to the correct pipe diameter and wall thickness (SDR) of the pipe to be squeezed. The plates are set correctly when the correct end face is pointing downwards and positioned to contact the bottom bar when this is re-fitted.

NOTE: On previous hydraulic squeezers the plates had straight sides; they are currently circular.



WARNING !

Ensure that both limit stoppers are fitted and they are positioned in the diameter and SDR corresponding to the pipe being squeezed.



WARNING !

For safety reasons, keep free the upper area of the squeezer from anyone in order to prevent possible accidents resulting from misuse or failure of any of the components involved in the operation.

4. With the hydraulic jack fully retracted (mechanically and hydraulically), mount the bridge set down. Mount the disc washers and nuts at the end of both axle bars (36 open-end spanner).

Pay attention to the correct pipe location: it must be located centrally between both vertical axle bars !

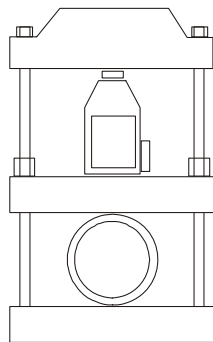

Figure 6

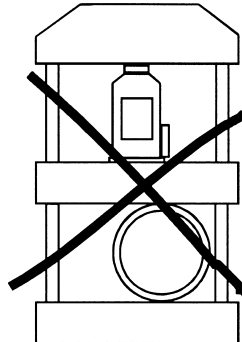

Figure 7: Wrong pipe location

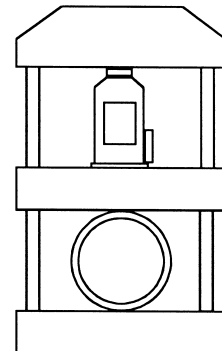

Figure 8: Correct pipe location

Whenever the pipe diameter to be squeezed permits, expand the mechanical threaded shaft until the jack will rest onto the movable bar jack bracket (it should be centered, set between the outer lips of the jack bracket).

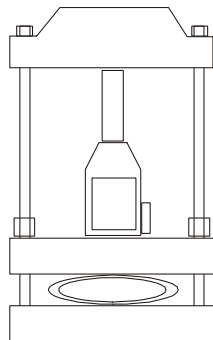

Figure 9

5. Next close the control valve by screwing clockwise with the jack handle. Fit the jack handle into the collar of the pump on the jack and start pumping the jack to initiate the squeeze pressuring.

IMPORTANT NOTE: For safety reasons, it is recommended do not overpass 100 mm travel of the hydraulic stem (total travel of 142 mm).

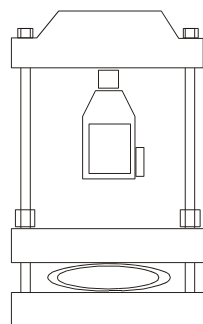

Figure 10

6. In case the 100 mm travel is already achieved, screw down both upper roller safety nuts until they are in contact with the upper edge of the squeeze bar. Then fully retract the jack hydraulic stem.

NOTE: The jack is retracted more easily if we remove the bridge assembly and with the valve open, leave it on the floor and we lean on it.

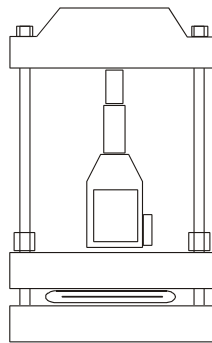

Figure 11

7. Mechanically fully extend the threaded rod. Next close the control valve by screwing clockwise with the jack handle and continue the pumping action until the squeezer upper roller has fully closed the pipe, and the limit stop plates prevent further compression.



WARNING !

Do not over tighten or remove the limit stop plates.

Do not use to squeeze off steel pipes or other applications or diameters and thicknesses other than those specified.

Do not mix components from other models.

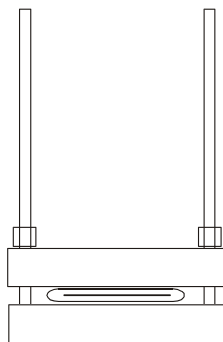

Figure 12

8. On completion of the squeeze off operation, screw fully down both upper roller safety nuts until they are in contact with the upper edge of the squeeze bar. The bridge assembly with the hydraulic jack can be removed for use elsewhere in the intervention.

After removing the squeezed off pipe from the squeezer, allow the section of squeezed pipe to reform to its original shape: this may take several hours, so better to use a re-rounding tool to help return the pipe to its original shape faster.

It is advisable taping or perform any registration or mark near on the area where the PE pipe has been squeezed to avoid repeat interventions on the same zone.



CAUTION !

Keep in mind that cutting operations of the pipeline there is potential risk of electrostatic discharge. Install grounding at each point of action.

CHAPTER 4: MAINTENANCE

4.1 GENERAL

4.1.1 **Introduction:**

As a general principle, we recommend to keep the squeezer (including all components and accessories) in perfect cleaning and oiling condition, ready for use.

Preventive maintenance of the equipment is minimal; just clean and lubricate the rod threads of the squeezer. Control the operating status of the hydraulic jack: condition of closing the valve, pressure losses through the pump stem gasket package. Should be defective, your shipment is recommended to any Grupo Acuster Service Centre for service and repair. Also check the oil level in the tank. Add oil if necessary.

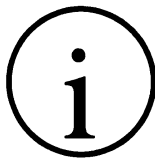

NOTE !

The oil level is determined by the height of the fill plug. For tank capacity and type of oil, see SECTION 5: TECHNICAL CHARACTERISTICS, of this *User Manual*.

4.1.2 **Storage:**

When not in use it is recommended to store the tool in an upright position to avoid oil leakages from the hydraulic jack. Also ensure that the pressure in the jack is released.

4.1.3 **Service:**

It is recommended to carry out a minimum of a year service shipping the tool to any Grupo Acuster Service Centre.

CHAPTER 5: TECHNICAL CHARACTERISTICS

5.1 GENERAL SPECIFICATIONS

Use	:	The squeezer has been designed to limit the flow in PE pipes.	
Range and squeezing off capacity	:	<u>Pipe wall thickness</u>	<u>Pipe Diameter</u>
	:	SDR 11	90-110-(125)-160-(180)-200
	:	SDR 17.6	90-110-160-200
	:	() Special limit stop plate	
Operation	:	Hydraulic jack, by manual operated pump.	
Hydraulic stem stroke (max):	:	142 mm	
Mechanical rod stroke (max):	:	60 mm	
Safety measures	:	Pressure valve, calibrated at maximum operating pressure.	
Oil type	:	SAE 10 (Shell Fluid AW46 or equivalent).	
Oil volume	:	1300 cm ³	
Weights	:	Bottom bar with rods	: 33 Kg
	:	Bridge frame with jack	: 26 Kg
	:	Total	: 59 Kg

